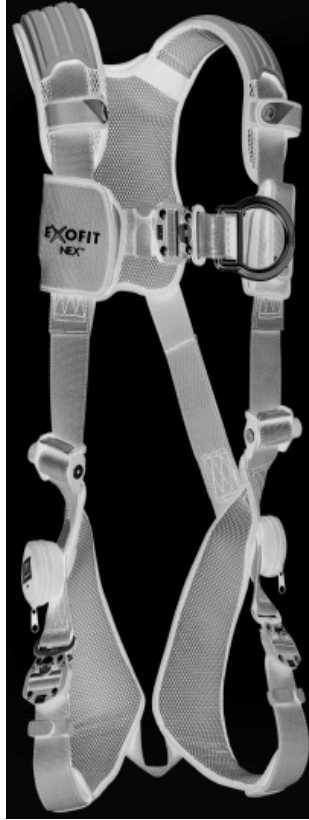




The Ultimate in Fall Protection

**48** SPECIFIC INSTRUCTIONS

**EXOFIT**  
NEX™



**EXOFIT NEX™**

**Full Body Harness**

Model Numbers:

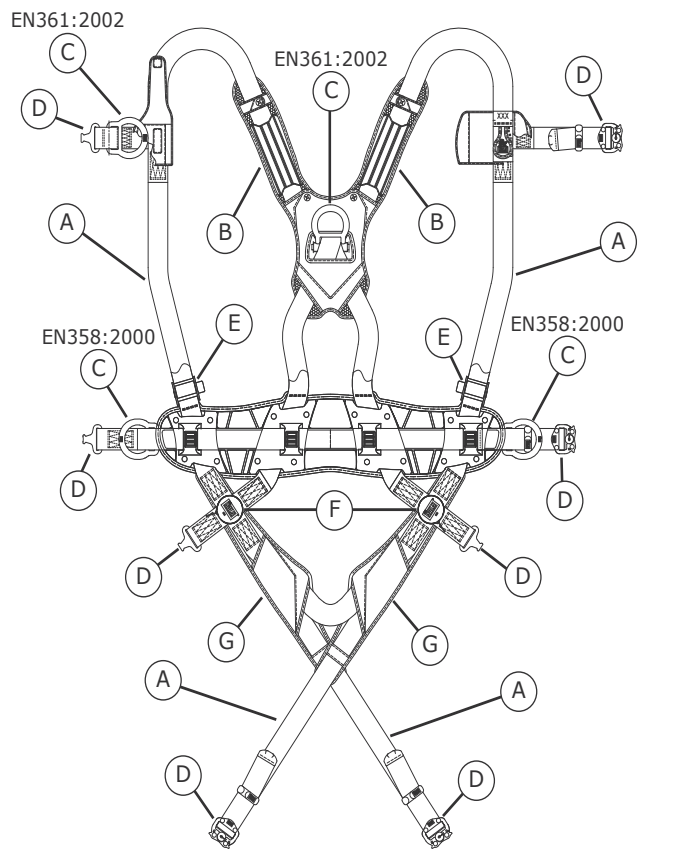
<b>1</b> <b>78</b>	1113174	1113215	1113454	1113906	1113951H
	1113175	1113216	1113455	1113907	1113952H
	1113176	1113217	1113456	1113908	1113953H
	1113177	1113218	1113457	1113909	1113992
	1113178	1113219	1113458	1113910	1113993
	1113179	1113264	1113900	1113911	1113994
	1113210	1113449	1113901	1113912	1113995
	1113211	1113450	1113902	1113913	
	1113212	1113451	1113903	1113914	
	1113213	1113452	1113904	1113919	
	1113214	1113453	1113905	1113950H	

<b>CE</b>	<b>3</b>	EN361:2002
	<b>3</b>	EN358:2000

<b>8</b> CE TYPE TEST	No. 0321 Satra Technology Centre Wyndham Way Telford Way Kettering, Northants NN16 8SD, UK
<b>9</b> USA CE PRODUCTION QUALITY CONTROL	No. 0086 BSI Product Services Kitemark Court Davy Avenue Knowlhill, Milton Keynes MK5 8PP, UK
<b>9</b> SLOVAKIA CE PRODUCTION QUALITY CONTROL	No. 1019 VVUU, a.s. Pikartska 1337/7 716 07 Ostrava-Radvanice Czech Republic

<b># = 49</b>	
<b># = 48</b>	

Component:	Material:	
<b>A</b> Repel Technology Webbing	<b>2</b> NanoSphere® treated Polyester	<b>18</b> <b>20</b>
<b>B</b> Hybrid Comfort Padding	<b>3</b> Nylon, Dri-Lex® Aerospace Mesh, Polyester & Nylon Mesh, Non-Slip Rubber	<b>51</b> <b>8</b> <b>9</b> <b>10</b>
<b>C</b> Tech-Lite™ D-Rings	<b>4</b> Aluminum	<b>28</b>
<b>D</b> Duo-Lok™ Quick Connect Buckles	<b>5</b> Zinc Plated Steel, Aluminum Alloy, Alloy Steel	<b>27</b> <b>28</b> <b>52</b>
<b>E</b> Revolver™ Vertical Torso Adjusters	<b>6</b> Zinc Plated Steel, Stainless Steel, Aluminum, Nylon	<b>27</b> <b>26</b> <b>28</b> <b>51</b>
<b>F</b> Suspension Trauma Straps	<b>7</b> Nylon, Zinc Plated Steel	<b>51</b> <b>27</b>
<b>G</b> Hybrid Comfort Padding	<b>3</b> Nylon, Dri-Lex® Aerospace Mesh, Evazote® VA 35 or PCF Crosslinked Polyurethane Foam	<b>51</b> <b>8</b> <b>11</b>

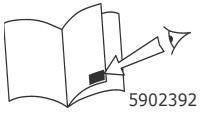


® NanoSphere® is a registered trademark of Schoeller Technologies AG, Switzerland (patent protected technology). Dri-Lex® is a registered trademark of Faytex Corp. Evazote® is a registered trademark of Zotefoams PLC.

## EN 1.0 FOREWORD

This instruction describes donning and use of the ExoFit NEX™ Full Body Harness. It should be used as part of an employee training program as required by CE.

**IMPORTANT:** Before using this equipment, record the product identification information from the Installation and Service Label on the Equipment Identification Sheet at the back of the "General Instructions for Use and Maintenance" (5902392).



General GLOSSARY REFERENCE BOXES: White Glossary Reference Boxes on the front cover of this instruction reference 'Glossary' items in the "General Instructions for Use and Maintenance" (5902392).



**SPECIFIC GLOSSARY REFERENCE BOXES:** Black Glossary Reference Boxes on the front cover of this instruction reference the following items:

**1:** Full Body Harness **2:** Repel Technology Webbing **3:** Hybrid Comfort Padding **4:** Tech-Lite™ D-Rings **5:** Duo-Lok™ Quick Connect Buckles **6:** Revolver™ Vertical Torso Adjusters **7:** Suspension Trauma Straps **8:** Dri-Lex® Aerospacer Mesh **9:** Polyester & Nylon Mesh **10:** Non-Slip Rubber **11:** Evazote® VA 35 or PCF Crosslinked Polyurethane Foam

## 2.0 PURPOSE

The DBI-SALA ExoFit NEX™ Full Body Harness should be used as a component in personal fall arrest, restraint, work positioning, climbing, or controlled descent systems.

## 3.0 DONNING AND USE

**WARNING:** Do not alter or intentionally misuse this equipment. Consult Capital Safety when using this equipment in combination with components or subsystems other than those described in this manual. Some subsystem and component combinations may interfere with the operation of this equipment. Use caution when using this equipment around moving machinery, electrical and chemical hazards, and sharp edges.

**3.1 BEFORE EACH USE:** Before each use of this equipment inspect the ExoFit NEX™ Full Body Harness according to Section 5 of this manual.

**3.2 PLANNING:** Plan your system before use. Consider all factors that will affect your safety during use of this equipment. Consider the following aspects when planning your system:

- **ANCHORAGE:** Select an anchorage that meets the anchorage requirements specified in Section 2.
- **SHARP EDGES:** Avoid working where system components may be in contact with, come in contact with, or abrade against, unprotected sharp edges.
- **AFTER A FALL:** Any equipment which has been subjected to the forces of arresting a fall, or exhibits damage consistent with the effect of fall arrest forces as described in Section 5, must be removed from service immediately and destroyed by the user, the rescuer<sup>1</sup>, or an authorized person<sup>2</sup>.
- **RESCUE:** The employer must have a rescue plan when using this equipment. The employer must have the ability to perform a rescue quickly and safely.

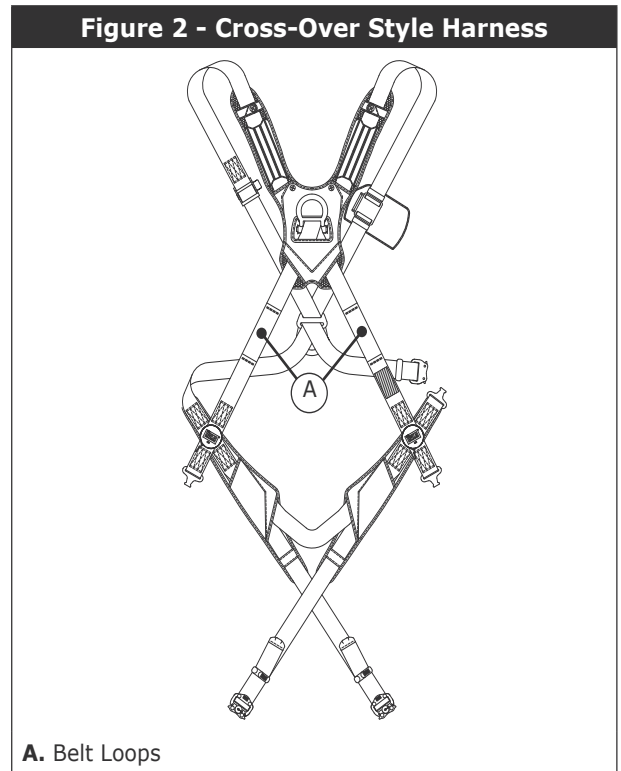
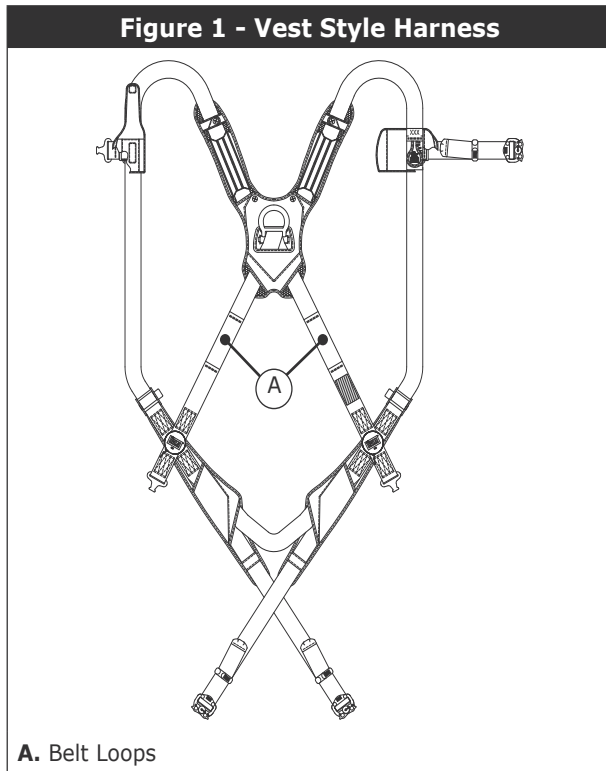
**3.3 DONNING AND FITTING THE HARNESS:** The ExoFit NEX™ Full Body Harness is available in Vest (Figure 1) and Cross-Over (Figure 2) styles. Donning procedures will vary with the harness style.



**WARNING:** Do not alter or intentionally misuse this equipment. Consult Capital Safety when using this equipment in combination with components or subsystems other than those described in this manual. Some subsystem and component combinations may interfere with the operation of this equipment. Use caution when using this equipment around moving machinery, electrical and chemical hazards, and sharp edges.



**A. EXOFIT NEX™ VEST STYLE FULL BODY HARNESS:** The ExoFit NEX™ Vest Style Harness incorporates loops for a removable waist belt (see Figure 1). The belt can be installed through the two loops in the harness located in the lower back shoulder straps. The belt will pass through the harness just below the padded area. The hip pad, if used, is secured to the belt by passing the belt through the hip pad loops. Don the Vest Style Full Body Harness per the following steps and corresponding images in Figure 3:



**1 Rescuer:** Person or persons other than the rescue subject acting to perform an assisted rescue by operation of a rescue system.

**2 Authorized Person:** A person assigned by the employer to perform duties at a location where the person will be exposed to a fall hazard (otherwise referred to as "user" for the purpose of these instructions).



- Step 1.** Locate back D-ring held in position by the D-ring pad; lift up harness and hold by this D-ring. Ensure the straps are not twisted.
- Step 2.** Grasp the shoulder straps and slip the harness onto one arm. The D-ring will be located on your back side. Ensure that the straps are not tangled and hang freely. Slip your free arm into the harness and position the shoulder straps on top of your shoulder. Ensure that the straps are not tangled and hang freely. The chest strap, with quick connect buckle, will be positioned on the front side when worn properly.
- Step 3.** Reach between your legs and grasp the gray leg strap on your left side. Bring the strap up between your legs and connect it by inserting the tab of the buckle into receptor of quick connect buckle on the left side as shown in Figure 3. You will hear a click when the tab engages properly. Connect the right leg strap using the same procedure. To adjust the leg straps, unlock  the webbing lock on the quick connect buckle and pull on the strap. A plastic end keeper on the end of the strap will stop it from pulling completely out of the buckle. When the strap is properly adjusted, lock  the webbing lock. To release the buckle, press the silver-colored tabs on the buckle towards each other with one hand, while pulling on the tab portion of the buckle with the other hand.

**NOTE:** Locking  and unlocking  the webbing lock prevents or allows the strap to slide between the sliding bar and slot on the female end of the quick connect buckle. It does not control engagement or disengagement of the buckle ends and will not affect the buckle connection in the event of a fall.

- Step 4.** Attach the chest strap by inserting the tab of the buckle into the receptor of the quick connect buckle. You will hear a click when the tab engages properly. The chest strap should be 15 cm down from the top of your shoulders. Pass excess strap through the loop keepers. To adjust the chest strap, unlock  the webbing lock on the quick connect buckle and pull on the strap. A plastic end keeper on the end of the strap will stop it from pulling completely out of the buckle. When the strap is properly adjusted, lock  the webbing lock. To release the buckle, press the silver-colored tabs on the buckle toward each other with one hand, while pulling on the tab portion of the buckle with the other hand.
- Step 5.** Adjust shoulder straps to a snug fit with the Vertical Torso Adjusters (see Figure 3): Left and right sides of shoulder straps should be adjusted to the same length and the chest strap should be centered on your lower chest, 15 cm down from shoulder. The front D-ring on the vest style harness is moved up or down by adjusting the shoulder straps and leg straps. Center the back D-ring between your shoulder blades. Note: On applicable models, the back (dorsal) D-ring can be repositioned up or down as needed for a correct fit. Adjust leg straps to a snug fit. At least 8 cm of webbing must extend past the buckle on the leg straps. Adjust the waist belt (if present).

**Figure 3 - Donning the ExoFit NEX™ Vest Style Full Body Harness**



**Step 1**



**Step 2**





**Step 3**

**Duo-Lok™ Quick Connect Buckles**



**Connection:** Connect buckle ends by inserting the tab into the receptor until a click is heard.



**Strap Adjustment:** Rotate Webbing Lock to unlocked position . Pull strap to adjust. Rotate Webbing Lock to locked position .

**NOTE:** The Webbing Lock does not control engagement or disengagement of the buckle ends.



**Step 4**

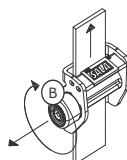
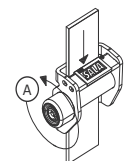
**Revolver™ Vertical Torso Adjusters**

**Right**

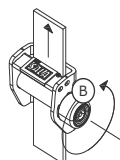
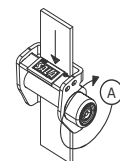
**To Tighten:** Turn Ratchet Knob in direction **A**.

**To Loosen:** Pull Ratchet Knob out and turn in direction **B**.

**NOTE:** After adjustment, tug upwards on the shoulder straps to ensure that each adjuster is locked in place.







**Left**



**Step 5**

**B. EXOFIT NEX™ CROSS-OVER STYLE FULL BODY HARNESS:** The ExoFit NEX™ Cross-Over Style Harness incorporates loops for a removable waist belt. The belt can be installed through the two loops in the harness located in the lower back shoulder straps (see Figure 2). The belt will pass through the harness just below the padded area. The hip pad, if used, is secured to the belt by passing the belt through the hip pad loops. Don the Cross-Over Style Full Body Harness per the following steps and corresponding images in Figure 4:

- Step 1.** Locate the back D-ring held in position by the D-ring pad; lift up the harness and hold by this D-ring. Ensure the straps are not twisted.
- Step 2.** Grasp the shoulder straps between the back and front D-ring and slip the harness over your head from the left side. Position the shoulder straps on top of your shoulders. Ensure that the straps are not tangled and hang freely. The D-ring will be positioned on your back when worn properly.
- Step 3.** Grasp the tab of the buckle located at your right hip and insert it into the receptor of the quick connect buckle (see Figure 4). You will hear a click when the tab engages properly.
- Step 4.** Reach between your legs and grasp the gray leg strap on your left side. Bring the strap up between your legs and insert the tab of the buckle into the receptor of the buckle on the left side as shown in Figure 4. You will hear a click when the tab engages properly. Connect the right leg strap using the same procedure. To adjust the leg straps, unlock  the webbing lock on the quick connect buckle and pull on the strap. A plastic end keeper on the end of the strap will stop it from pulling completely out of the buckle. When the strap is properly adjusted, lock  the webbing lock. To release the buckle, press the silver-colored tabs on the buckle towards each other with one hand, while pulling on the tab portion of the buckle with the other hand.

**NOTE:** Locking  and unlocking  the webbing lock prevents or allows the strap to slide between the sliding bar and slot on the female end of the quick connect buckle. It does not control engagement or disengagement of the buckle ends and will not affect the buckle connection in the event of a fall.

- Step 5.** Adjust shoulder straps to a snug fit with the Vertical Torso Adjusters (see Figure 4): Left and right sides of the shoulder straps should be adjusted to the same length and the front D-ring should be centered on your lower chest. The back D-ring should be centered between your shoulder blades. Note: On ExoFit XP models, the back (dorsal) D-ring can be repositioned up or down as needed for a correct fit. Adjust the leg straps to a snug fit. At least 8 cm of webbing must extend past the buckle on the leg straps. Adjust the waist belt (if present).

**3.4 USE OF FALL ARREST D-RING OR ATTACHMENT ELEMENT:** For fall arrest applications (EN361) connect to the D-ring or attachment element on your back, between your shoulder blades; or any other D-ring marked clearly with an "A". The Front D-ring, if present, is for fall arrest, ladder climbing, positioning, or other applications. Side D-rings, if present, are for positioning (EN358) or restraint applications (EN354) only. D-rings on the seat sling are for work positioning or personnel riding.

**3.5 MAKING CONNECTIONS:** When using a hook to connect to an anchorage or when coupling components of the system together, ensure roll-out cannot occur. Roll-out occurs when interference between the hook and mating connector causes the hook gate to unintentionally open and release. Self-locking snap hooks and carabiners should be used to reduce the possibility of roll-out. Do not use hooks or connectors that will not completely close over the attachment object. See subsystem manufacturer's instructions for more information on making connections.

**3.6 CONNECTING SYSTEM COMPONENTS:** After properly fitting the full body harness, the user may then connect to other system components. Follow the guidelines in Section 3.4 when selecting the correct attachment element.

**Figure 3 - Donning the ExoFit NEX™ Cross-Over Style Full Body Harness**



**Step 1**



**Step 2**



**Step 3**





**Step 4**

**Duo-Lok™ Quick Connect Buckles**



**Connection:** Connect buckle ends by inserting the tab into the receptor until a click is heard.



**Strap Adjustment:** Rotate Webbing Lock to unlocked position . Pull strap to adjust. Rotate Webbing Lock to locked position .

**NOTE:** The Webbing Lock does not control engagement or disengagement of the buckle ends.

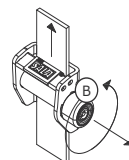
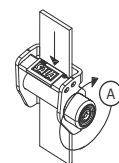
**Revolver™ Vertical Torso Adjusters**

**To Tighten:** Turn Ratchet Knob in direction **A**.

**To Loosen:** Pull Ratchet Knob out and turn in direction **B**.

**NOTE:** After adjustment, tug upwards on the shoulder straps to ensure that each adjuster is locked in place.

**Left**



**Step 5**

**3.7 SUSPENSION TRAUMA STRAP:** Some models of the ExoFit NEX™ Full Body Harness are equipped with a Suspension Trauma Strap (Figure 5) to help prolong allowable suspension time in the event of a fall from height. It should only be used in situations where a fall has occurred or for training. To use the Suspension Trauma Strap:

- Step 1.** Unzip the Trauma Strap Pouch on each hip of the harness and deploy the Suspension Straps (Figure 5A).
- Step 2.** Raise the ends of the straps to access the hook and loops. Insert the hook into the loop that provides the desired strap length.
- Step 3.** Lower the Suspension Strap and step onto the strap to alleviate pressure of the harness leg straps on the legs (Figure 5B). Adjust the hook/loop combination for optimal comfort.

**WARNING:** Seek medical attention following a suspension.

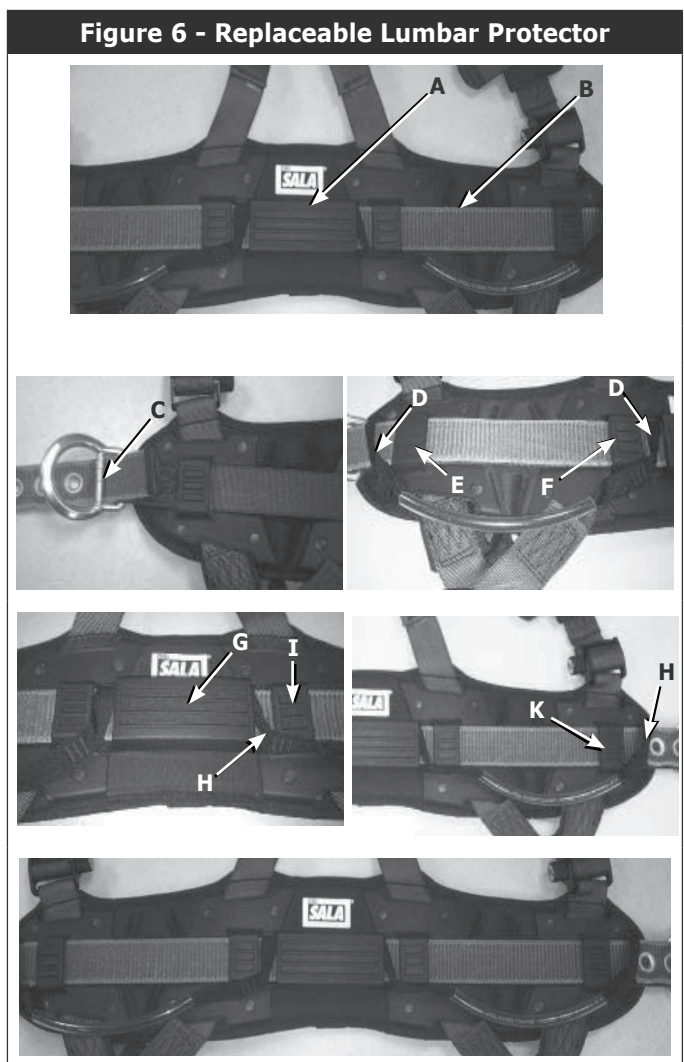


**3.8 EXOFIT NEX GLOBAL WIND ENERGY HARNESS MODEL REPLACEABLE LUMBAR PROTECTOR:** The Lumbar Protector (A) can be replaced in the field when worn or damaged (See Figure 6).

Place the ExoFit harness on a flat surface. Pull the hip belt (B) completely out of the harness to free the worn/damaged Lumbar Protector (A) and tool loops (D, if installed).

To install the replacement Lumbar Protector:

- Step 1.** Reinsert the hip belt through the left D-Ring (C), the end of the first tool loop (D, if installed), belt loops (E) and (F), and the end of the tool loop (D).
- Step 2.** Insert the hip belt through the replacement Lumbar Protector (G), the second tool loop (H, if installed), the next two belt loops (I) and (K), the end of the tool loop (H) and the right D-Ring.



## 4.0 TRAINING

It is the responsibility of the purchaser and the user of this equipment to assure that they understand these instructions and are trained in the correct care and use of this equipment. They must also be aware of the operating characteristics, application limits, and the consequences of improper use of this equipment.

**IMPORTANT:** Training must be conducted without exposing the user to a fall hazard. Training should be repeated on a periodic basis.

## 5.0 INSPECTION

**5.1 i-Safe™ RFID TAG:** The i-Safe™ RFID tag on the ExoFit NEX™ Harness (see Figure 7) can be used in conjunction with the i-Safe handheld reading device and the web based portal to simplify inspection and inventory control and provide records for your fall protection equipment.

**5.2 FREQUENCY:** Before each use inspect the full body harness according to Section 5.3. The harness must be inspected by a competent person<sup>3</sup>, other than the user, at least annually. Record the results of each formal inspection in the Periodic Examination and Repair History at the back of the "General Instructions for Use and Maintenance" (5902392), or use the i-Safe™ inspection web portal to maintain your inspection records. If you are a first-time user, contact Capital Safety (see back cover). If you have already registered, go to: [www.capitalsafety.com/isafe](http://www.capitalsafety.com/isafe). Follow instructions provided with your i-Safe handheld reader or on the web portal to transfer your data to your web log.

**IMPORTANT:** If the full body harness has been subjected to fall arrest or impact forces it must be immediately removed from service and destroyed.

**IMPORTANT:** Extreme working conditions (harsh environments, prolonged use, etc.) may require increasing the frequency of inspections.

**5.3 INSPECTION:** Inspect the ExoFit NEX™ Full Body Harness as follows:

- Step 1. Inspect harness hardware (buckles, D-rings, pads, loop keepers, vertical torso adjusters):** These items must not be damaged, broken, distorted, and must be free of sharp edges, burrs, cracks, worn parts, or corrosion. PVC coated hardware must be free of cuts, rips, tears, holes, etc. in the coating to ensure non-conductivity. Ensure that release tabs on buckles work freely and that a click is heard when the buckle engages. Inspect vertical torso adjusters for proper operation. Ratchet knobs should turn with ease in a clockwise direction and should only turn counterclockwise when the knob is pulled out. Readjust buckles and pads periodically to expose and inspect hidden areas on webbing and hardware.
- Step 2. Inspect webbing:** Material must be free of frayed, cut, or broken fibers. Check for tears, abrasions, mold, burns, or discoloration. Inspect stitching; check for pulled or cut stitches. Broken stitches may be an indication that the harness has been impact loaded and must be removed from service. When performing the annual formal inspection, unsnap and open the back pad to facilitate inspection of the webbing.
- Step 3. Inspect the labels:** All labels should be present and fully legible (see back pages).
- Step 4. Inspect system components and subsystems:** Inspect each system component or subsystem according to manufacturer's instructions.
- Step 5. Record inspection data:** Record the inspection date and results on the Periodic Examination and Repair History at the back of the "General Instructions for Use and Maintenance" (5902392).
- Step 6. Inspect the Stitched Impact Indicator:** The stitched impact indicator is a section of webbing that is lapped back on itself and secured with a specific stitch pattern holding the lap (see Figure 8). The stitch pattern is designed to release when the harness arrests a fall or has been subjected to an equivalent force. If the impact indicator has been activated the harness must be removed from service and destroyed.
- Step 7. Inspect Suspension Trauma Straps:** Check the trauma strap pouches for damage and secure connection to the harness. Unzip the trauma strap pouch on each hip of the harness and inspect suspension trauma straps. Webbing and pouch material must be free of frayed, cut, or broken fibers. Check for tears, abrasions, mold, burns, discoloration, or knots. Verify that one pouch is marked 'Hook' and the other marked 'loop'.

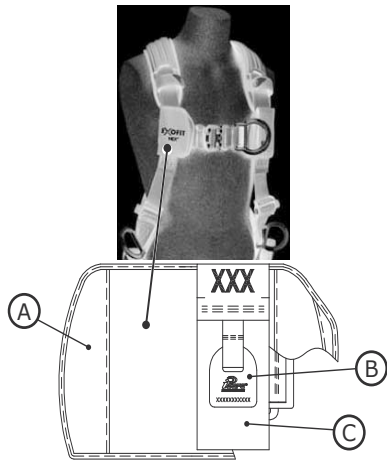
**IMPORTANT:** If inspection reveals a defective condition, remove the unit from service immediately and destroy it.

**3 Competent Person:** One who is capable of identifying existing and predictable hazards in the surroundings or working conditions which are unsanitary, hazardous, or dangerous to employees, and who has authorization to take prompt corrective measures to eliminate them.

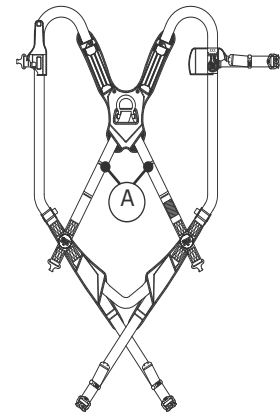


**Figure 7 - i-Safe™ RFID Tag**

<b>A</b>	Wrap-Around Cover
<b>B</b>	i-Safe™ RFID Tag
<b>C</b>	Product Labels



**Figure 8 - Stitched Impact Indicator**



**A** Stitched Impact Indicator

## 6.0 MAINTENANCE, SERVICING, AND STORAGE

**NOTE:** Only Capital Safety or parties authorized in writing may make repairs to this equipment.

**6.1 WASHING INSTRUCTIONS:** Washing procedures for the ExoFit NEX™ Full Body Harness are as follows:

**Step 1.** Spot clean the ExoFit NEX™ Full Body Harness with water and a mild soap solution. The harness may be laundered by using a bleach-free detergent. Water temperature for wash and rinse must not exceed 70° C.

**Step 2.** The harness may be laundered by using a bleach-free detergent. Water temperature for wash and rinse must not exceed 70° C.

**Step 3.** The harness and pads may be air dried or tumble dried on low heat not exceeding 90° C.

**IMPORTANT:** Use a bleach-free detergent when washing the harness and pads. Fabric softener or dryer sheets **SHOULD NOT** be used when laundering and drying the harness and pads.

**NOTE:** More information on cleaning is available from Capital Safety. If you have questions concerning the condition of your harness, or have any doubt about putting it into service contact Capital Safety.

**6.2 STORAGE:** Store the ExoFit NEX™ Full Body Harness in a cool, dry, clean environment out of direct sunlight. Avoid areas where chemical vapors may exist. Thoroughly inspect the full body harness after extended storage. Adjust buckles to full extension and remove padding (where applicable) to facilitate drying. Thoroughly inspect the full body harness after extended storage.