



The Ultimate in Fall Protection











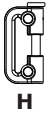
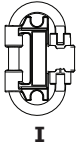

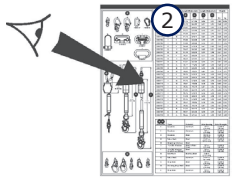

CE	EN 360: 2002
CE Type Test No. 0321 Satra Technology Centre Wyndham Way Telford Way Kettering, Northants NN16 8SD, UK	CE Production Quality Control No. 0086 BSI Product Services Kitemark Court Davy Avenue Knowlhill, Milton Keynes MK5 8PP, UK





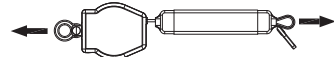
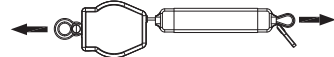
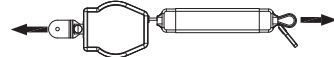
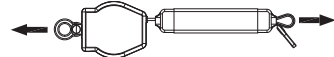
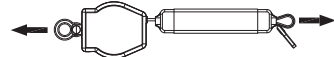
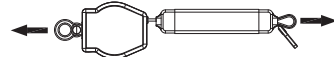
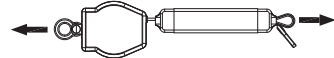
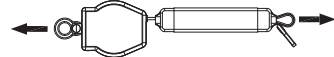
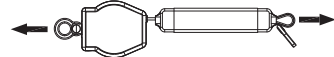
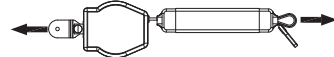
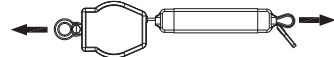
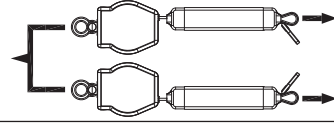
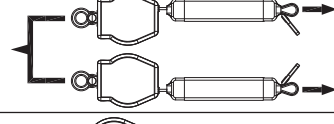
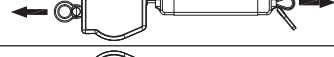

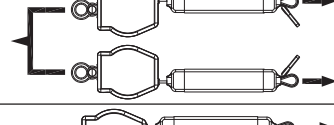





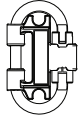



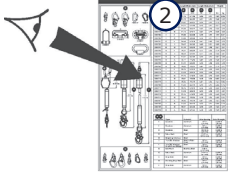

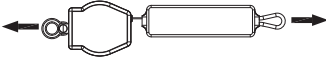

NANO-LOK™

SELF RETRACTING LIFELINES

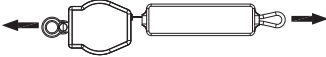
Model Numbers: (See Figure 1)

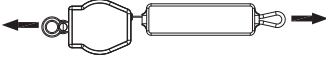
INSTRUCTION MANUAL

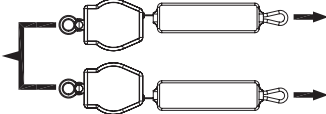
1													
													
3101207		1										1	
3101208					1							1	
3101209						1				1			
3101260		1						1					
3101261		1							1				
3101262		1								1			
3101263					1				1				
3101264					1					1			
3101265				1				1					
3101266	1									1			
3101461				1								1	
3101270			1						2				
3101298			1									2	
3101487					1							1	
3101467					1			EN 362					
3101201			1					EN 362					
3101205	EN 362								EN 362				

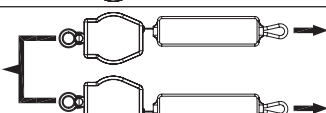
1												
												
 3101521		1							1			
 3101522		1									1	
 3101523				1				1				
 3101524			1						2			
 3101525			1								2	

 **Hot Work** - Fire Resistant Nano-Lok™ SRLs

CE Type Test	CE Production Quality Control
No. 0086 BSI Product Services Kitemark Court Davy Avenue Knowlhill, Milton Keynes MK5 8PP, UK	No. 0086 BSI Product Services Kitemark Court Davy Avenue Knowlhill, Milton Keynes MK5 8PP, UK

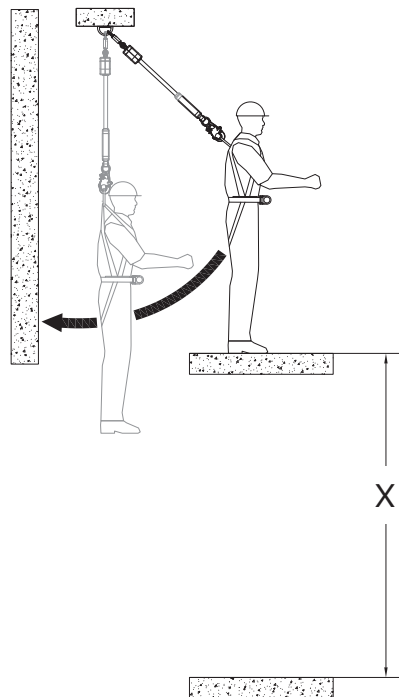
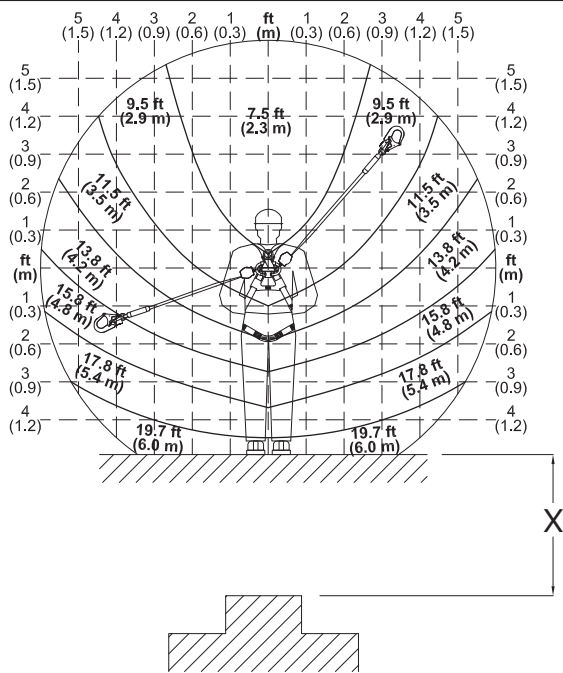
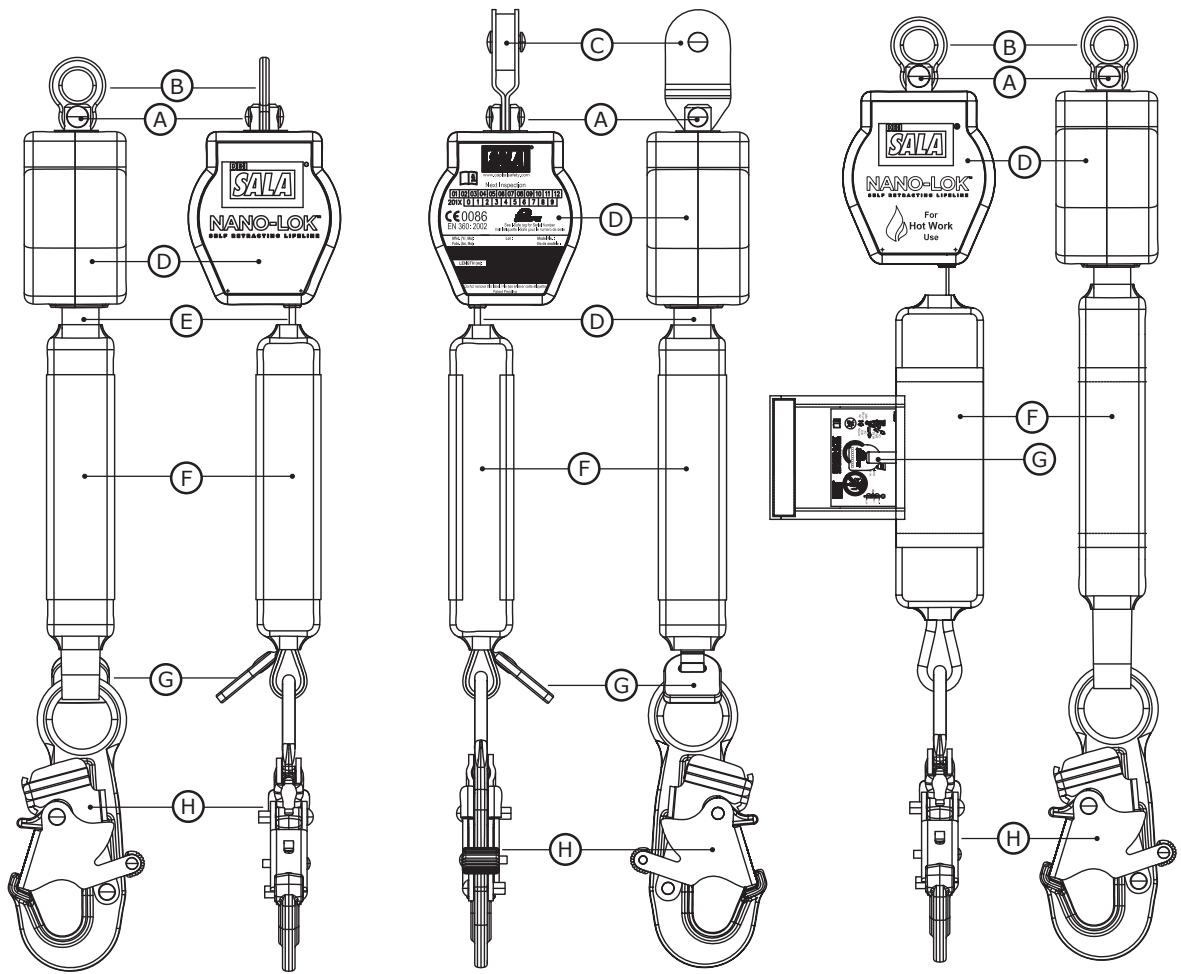

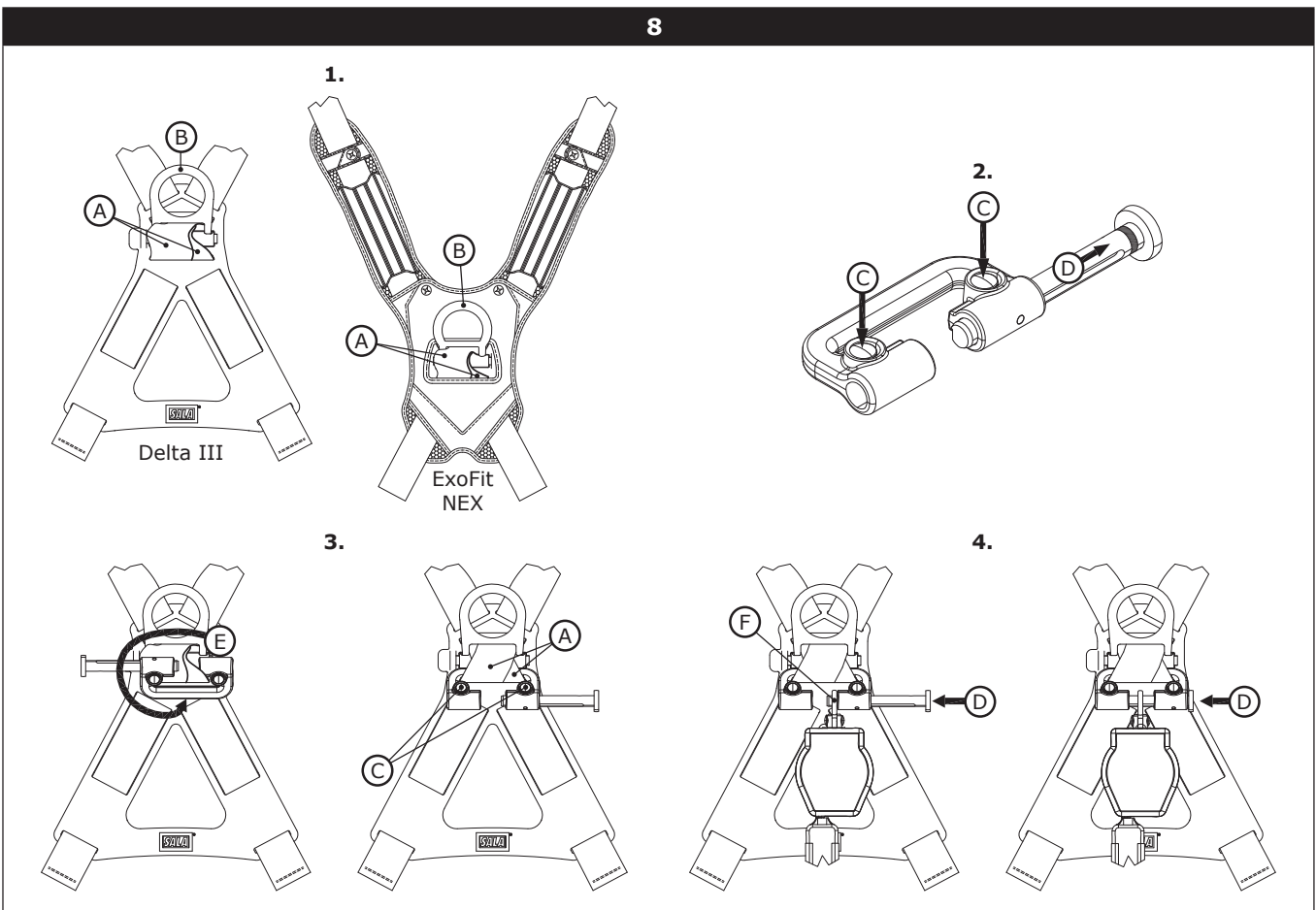
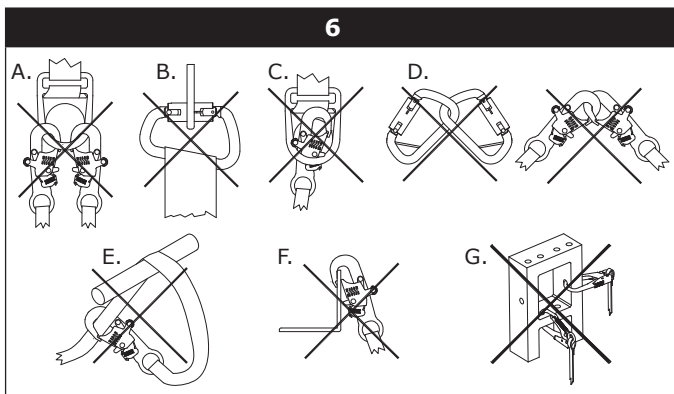
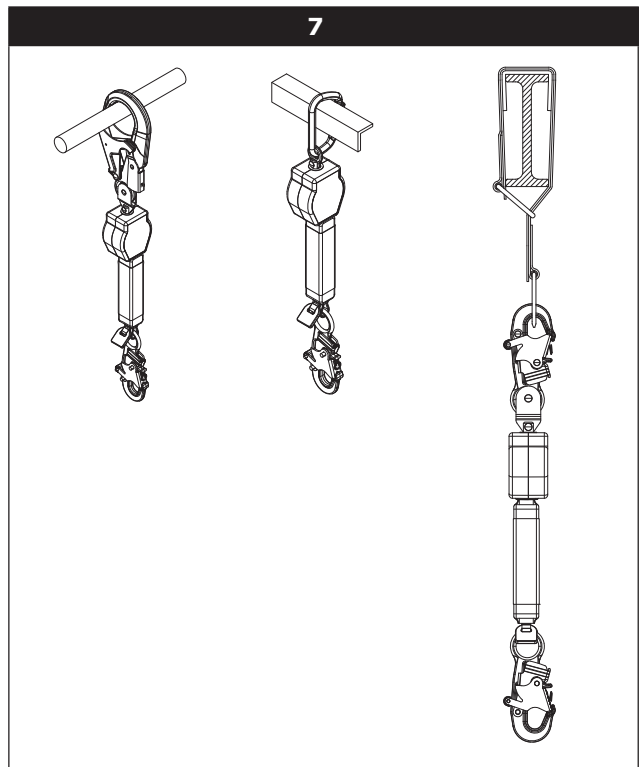
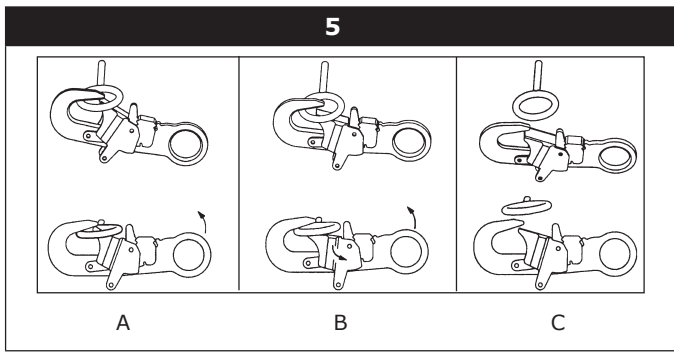

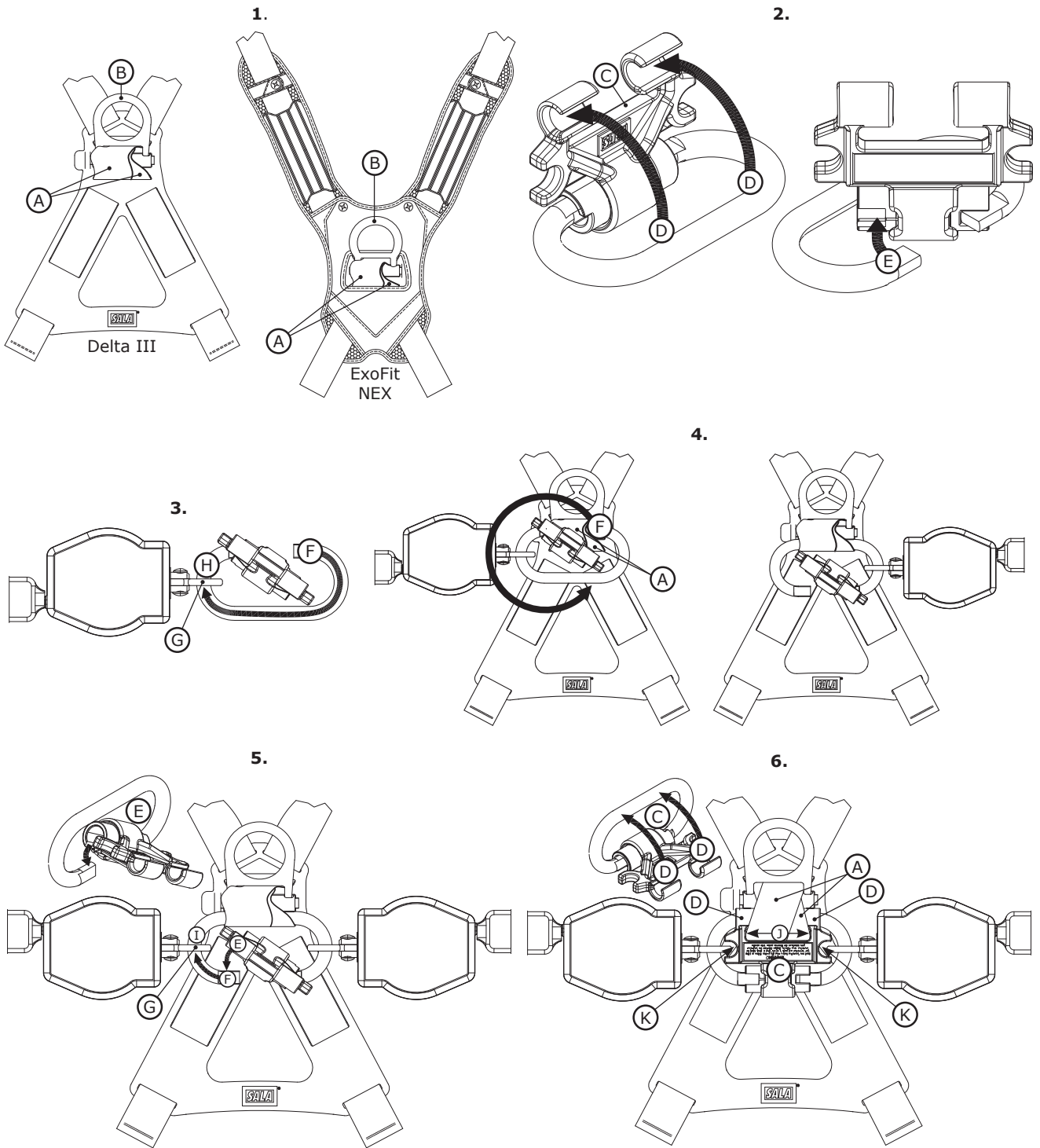

10

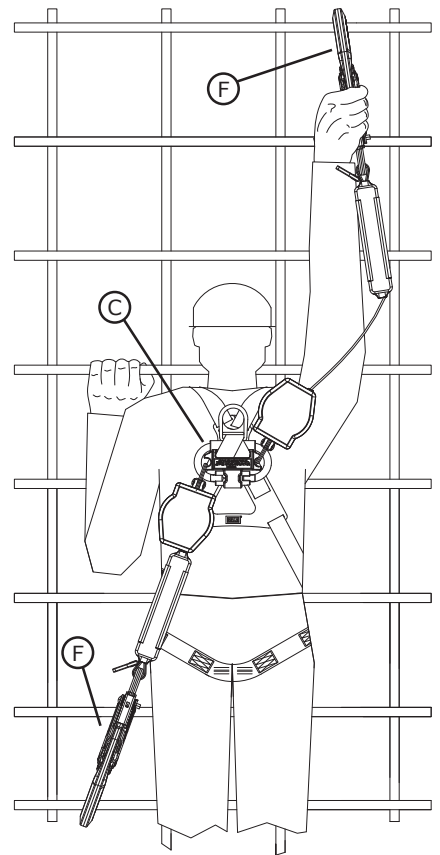
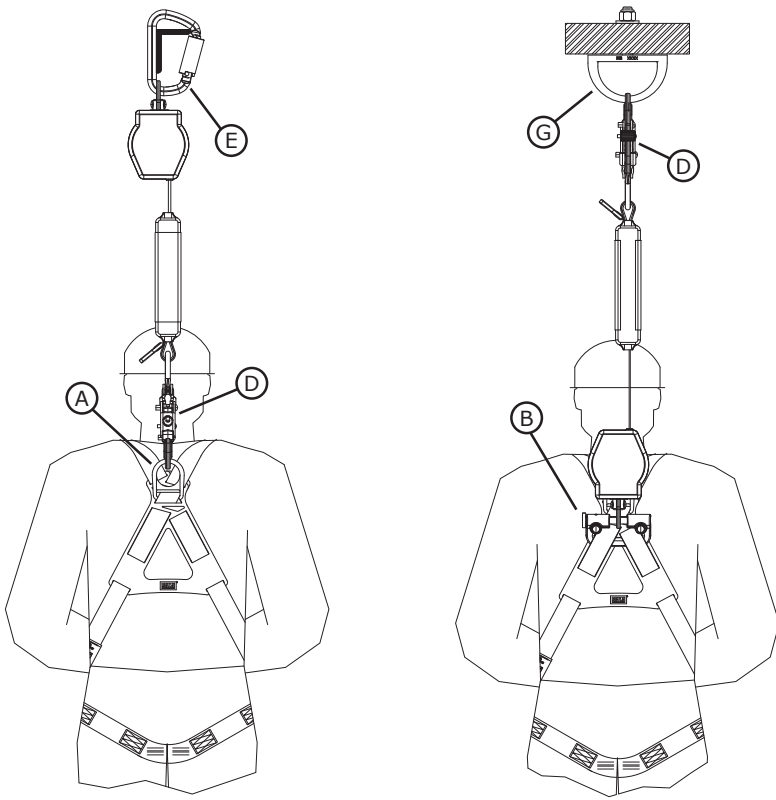

11

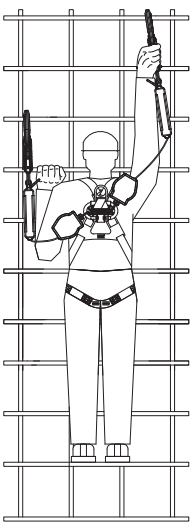

12

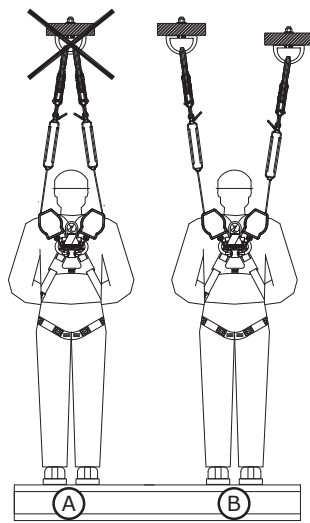

13

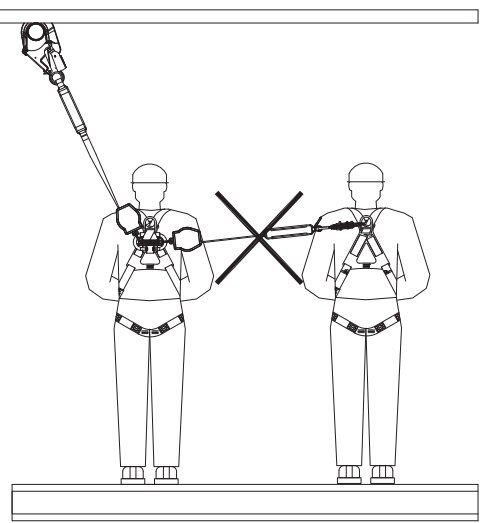

14

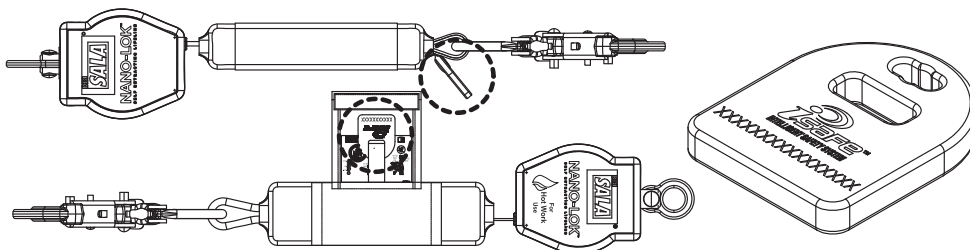

1.

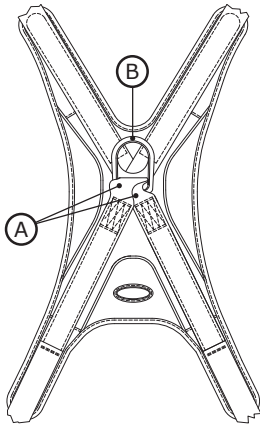

2.

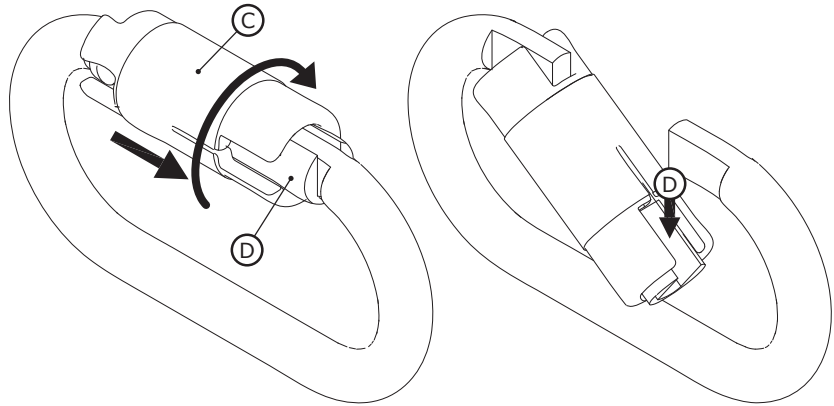

3.

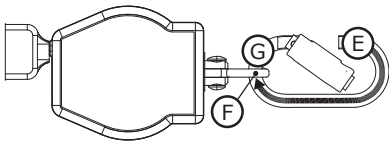

4.

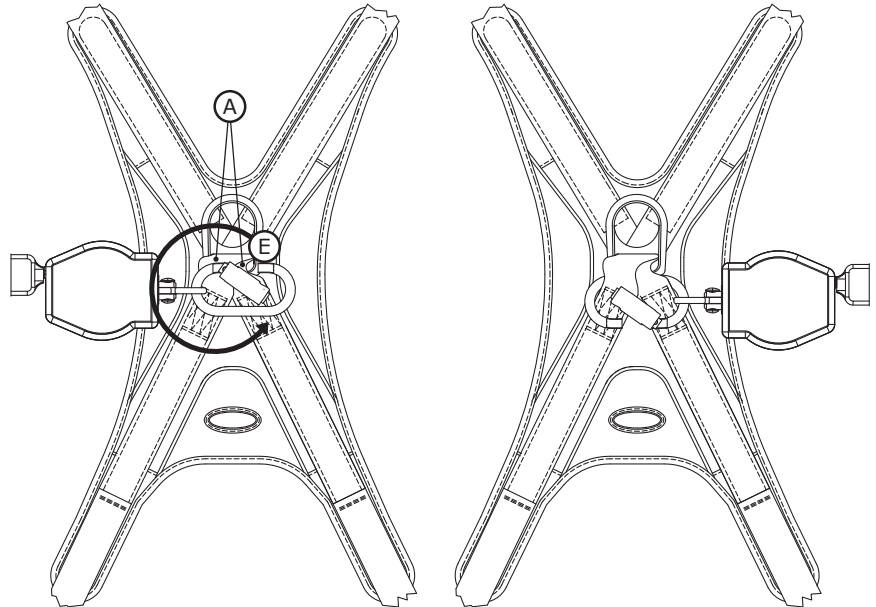

5.

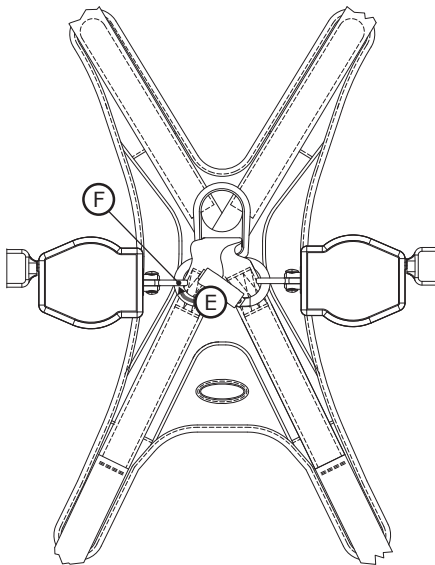

6.

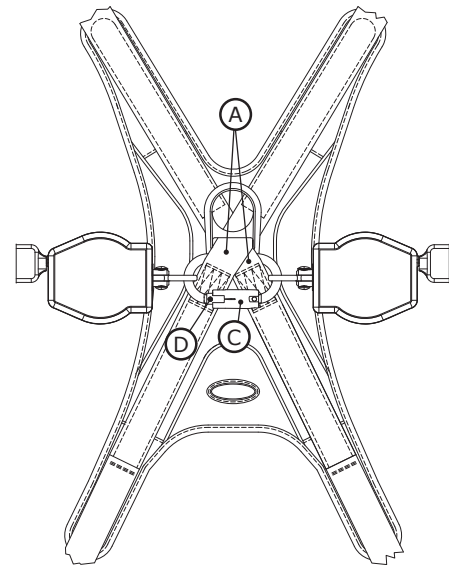

 This product is part of a personal fall arrest, work positioning, or rescue system. These instructions must be provided to the user of this equipment. The user must read and understand these instructions before using this equipment. Manufacturer's instructions must be followed for proper use and maintenance of this equipment. Alterations or misuse of this product or failure to follow instructions may result in serious injury or death. If this product is resold outside the original country of destination, the re-seller must provide these instructions in the language of the country in which the product will be used.

IMPORTANT: If you have questions on the use, care, or suitability of this equipment for your application, contact Capital Safety.

IMPORTANT: Before using this equipment, record the product identification information from the ID label in the inspection and maintenance log of this manual.

DESCRIPTION:

The Nano-Lok™ SRLs are 6 ft. (2 m) Lanyards, equipped with an in-line Load Indicator, which retract into a Thermoplastic Housing. They are available in multiple model configurations that allow attachment to an anchorage point, single or dual mounting on a Full Body Harness (see Figure 1). The Nano-Lok™ SRL automatically locks at the onset of a fall to arrest the fall, but pays out and retracts lifeline during normal movement by the attached user. Figure 2 illustrates the following key components of the base Nano-Lok™ Self Retracting Lifeline (SRL): Swivel (A), Swivel Eye (B), Integral Connector (C), Housing (D), Web Lifeline (E), Load Indicator (F), iSafe™ RFID Tag (G), Lifeline Hook (H).

1.0 APPLICATIONS

- 1.1 PURPOSE:** Capital Safety Self Retracting Lifelines (SRLs) are designed to be a component in a personal fall arrest system (PFAS). Figure 1 illustrates SRL models covered by this instruction manual. They may be used in most situations where a combination of worker mobility and fall protection is required (i.e. inspection work, general construction, maintenance work, oil production, confined space work, etc.).

 **HOT WORK:** Fire resistant "Hot Work" models are available for welding, foundry work, etc. where the SRL may be exposed to sparks or flames.

- 1.2 STANDARDS:** Your SRL conforms to the CE standard(s) identified on the front cover of these instructions.
- 1.3 TRAINING:** This equipment is intended to be used by persons trained in its correct application and use. It is the responsibility of the user to assure they are familiar with these instructions and are trained in the correct care and use of this equipment. Users must also be aware of the operating characteristics, application limits, and the consequences of improper use.

2.0 LIMITATIONS & REQUIREMENTS

Always consider the following limitations and requirements when installing or using this equipment:

- 2.1 CAPACITY:** SRLs are designed for use by one person with a combined weight (person, clothing, tools, etc.) not exceeding 310 lbs (141 kg).

At no time shall more than one person connect to a single SRL for fall arrest applications.

- 2.2 ARREST FORCE:** SRLs documented in this instruction meet the following Arrest Force values:

Average Arresting Force	Maximum Arresting Force
900 lbs (4.0 kN)	1,350 lbs (6.0 kN)

- 2.3 ANCHORAGE:** Anchorage structure for the SRL must be capable of supporting loads up to 2,248 lbs (10 kN). Anchor devices must conform to EN795.
- 2.4 RESCUE PLAN:** When using this equipment, the employer must have a rescue plan and the means at hand to implement it and communicate that plan to users, authorized persons, and rescuers.
- 2.5 INSPECTION FREQUENCY:** The SRL shall be inspected by the user before each use and, additionally, by a Competent Person¹ other than the user at intervals of no more than one year². Inspection procedures are described in the "Inspection & Maintenance Log" (Table 1). Results of each Competent Person inspection should be recorded on copies of the "Inspection & Maintenance Log" (Table 1) or recorded with the i-Safe™ system (see Section 5).
- 2.6 LOCKING SPEED:** Situations which do not allow for an unobstructed fall path should be avoided. Working in confined or cramped spaces may not allow the body to reach sufficient speed to cause the SRL to lock if a fall occurs. Working on slowly shifting material, such as sand or grain, may not allow enough speed buildup to cause the SRL to lock. A clear path is required to assure positive locking of the SRL.
- 2.7 NORMAL OPERATIONS:** Normal operation will allow the full length of the lifeline to extend and retract with no hesitation when extending and no slack when retracting as the worker moves at normal speeds. If a fall occurs, a speed sensing brake system will activate, stopping the fall and absorbing much of the energy created. For falls which occur near the end of the lifeline travel, a reserve lifeline system or Load Indicator has been incorporated to assure a reduced impact fall arrest. If the SRL has been subjected to fall forces, it must be taken out of service and inspected (see Section 5). Sudden or quick movements should be avoided during normal work operation, as this may cause the SRL to lock up.

1 Competent Person: One who is capable of identifying existing and predictable hazards in the surroundings or working conditions which are unsanitary, hazardous, or dangerous to employees, and who has authorization to take prompt corrective measures to eliminate them.

2 Inspection Frequency: Extreme working conditions (harsh environments, prolonged use, etc.) may require increasing the frequency of competent person inspections.

- 2.8 FREE FALL:** When anchored overhead, SRLs will limit the free fall distance to 2 ft. (61 cm) or less. To avoid increased fall distances, anchor the SRL directly above the work level. Avoid working where your lifeline may cross or tangle with that of another worker. Avoid working where an object may fall and strike the lifeline; resulting in loss of balance or damage to the lifeline. Do not allow the lifeline to pass under arms or between legs. Never clamp, knot, or prevent the lifeline from retracting or being taut. Avoid slack line. **Do not lengthen SRL by connecting a lanyard or similar component without consulting Capital Safety.**
- 2.9 FALL CLEARANCE:** Figure 3 illustrates Fall Clearance requirements. Ensure adequate clearance (X) exists in the fall path to prevent striking an object during a fall. If the worker will be working at a position that is not directly below the SRL anchorage point, the clearance required and vertical fall distance will be greater.

To determine the clearance required: Measure the distance from the user's harness dorsal connection to the anchorage for the Nano-Lok SRL. Both horizontal and vertical distances are required. Use Figure 3 to determine the required clearance (X). The dotted lines in the figure represent 1 foot (0.3 m) increments from the user's harness dorsal connection to the anchorage. For example, 9.5 ft (2.9 m) of clearance is required when the Nano-Lok unit is anchored 3 1/2 ft (1 m) above and 3 1/2 ft (1 m) to the side of the user's harness dorsal connection. 15.8 ft (4.8 m) of clearance is required when the Nano-Lok is anchored 1 1/2 ft (0.5 m) below and 4 1/2 ft (1.4 m) to side of the user's dorsal connection.

NOTE: The clearances provided in Figure 3 assume the fall occurs from the standing position. If the worker is kneeling or crouching an additional 3 ft (0.9 m) of clearance is needed.

- 2.10 SWING FALLS:** Swing falls occur when the anchorage point is not directly above the point where a fall occurs (see Figure 4). The force of striking an object in a swing fall may cause serious injury. In a swing fall, the total vertical fall distance will be greater than if the user had fallen directly below the anchorage point, thus increasing fall clearance (X) required to safely arrest the user. Use Figure 3 to determine the fall clearance (X) for your application. Minimize swing falls by working as directly below the anchorage point as possible. Never permit a swing fall if injury could occur.
- 2.11 HAZARDS:** Use of this equipment in areas where surrounding hazards exist may require additional precautions to reduce the possibility of injury to the user or damage to the equipment. Hazards may include, but are not limited to: high heat, caustic chemicals, corrosive environments, high voltage power lines, explosive or toxic gases, moving machinery, sharp edges, or overhead materials that may fall and contact the user or fall arrest system.
- 2.12 SHARP EDGES:** Avoid working where the lifeline will be in contact with or abrade against unprotected sharp edges. Where contact with a sharp edge is unavoidable, cover the edge with a protective material.
- 2.13 BODY SUPPORT:** A Full Body Harness must be used with the Self Retracting Lifeline. The harness connection point must be above the user's center of gravity. A body belt is not authorized for use with the Self Retracting Lifeline. If a fall occurs when using a body belt it may cause unintentional release and possible suffocation because of improper body support.
- 2.14 COMPATIBILITY OF COMPONENTS:** Unless otherwise noted, Capital Safety equipment is designed for use with Capital Safety approved components and subsystems only. Substitutions or replacements made with non approved components or subsystems may jeopardize compatibility of equipment and may affect safety and reliability of the complete system.

IMPORTANT: Read and follow manufacturer's instructions for associated components and subsystems in your personal fall arrest system.

- 2.15 COMPATIBILITY OF CONNECTORS:** Connectors are considered to be compatible with connecting elements when they have been designed to work together in such a way that their sizes and shapes do not cause their gate mechanisms to inadvertently open regardless of how they become oriented. Contact Capital Safety if you have any questions about compatibility.

Connectors used to suspend the SRL must comply with EN362. Connectors must be compatible with the anchorage or other system components. Do not use equipment that is not compatible. Non-compatible connectors may unintentionally disengage (see Figure 5). Connectors must be compatible in size, shape, and strength. Self-locking snap hooks and carabiners are required. If the connecting element to which a snap hook or carabiner attaches is undersized or irregular in shape, a situation could occur where the connecting element applies a force to the gate of the snap hook or carabiner (A). This force may cause the gate to open (B), allowing the snap hook or carabiner to disengage from the connecting point (C).

- 2.16 MAKING CONNECTIONS:** Snap hooks and carabiners used with this equipment must be self-locking. Ensure all connections are compatible in size, shape and strength. Do not use equipment that is not compatible. Ensure all connectors are fully closed and locked.

Capital Safety connectors (snap hooks and carabiners) are designed to be used only as specified in each product's user's instructions. See Figure 6 for examples of inappropriate connections. Do not connect snap hooks and carabiners:

- A. To a D-ring to which another connector is attached.
- B. In a manner that would result in a load on the gate.
- C. In a false engagement, where features that protrude from the snap hook or carabiner catch on the anchor, and without visual confirmation seems to be fully engaged to the anchor point.
- D. To each other.
- E. Directly to webbing or rope lanyard or tie-back (unless the manufacturer's instructions for both the lanyard and connector specifically allows such a connection).
- F. To any object which is shaped or dimensioned such that the snap hook or carabiner will not close and lock, or that roll-out could occur.
- G. In a manner that does not allow the connector to align properly while under load.

3.0 INSTALLATION

- 3.1 PLANNING:** Plan your fall protection system before starting your work. Account for all factors that may affect your safety before, during, and after a fall. Consider all requirements and limitations defined in Section 2.

IMPORTANT: In most applications, the Nano-Lok SRL can be connected to the anchorage or the harness Dorsal location. Either orientation is allowed; except as noted in Section 4.7.

- 3.2 ANCHORAGE:** Figure 7 illustrates typical SRL anchorage connections. Select an anchorage location with minimal free fall and swing fall hazards (see Section 2). Select a rigid anchorage point capable of sustaining the static loads defined in Section 2.2. Where anchoring overhead is not feasible, Nano-Lok SRLs may be secured to an anchorage point below the level of the user's Dorsal D-Ring. For users up to 310 lbs, (141 kg) the anchorage point must not be more than 5 ft (1.5 m) below the Dorsal D-Ring.

- 3.3 HARNESS MOUNTING:** Some Nano-Lok SRL models include a Single SRL or Twin SRL Harness Interface for mounting the SRL(s) on a Full Body Harness just below the Dorsal D-Ring (see Figures 8 and 9):

- **Single SRL Harness Interface:** Where worker mobility is critical, a Single SRL Harness Interface can be used to mount the Nano-Lok SRL on the back of a Full Body Harness just below the Dorsal D-Ring (see Figure 8). The worker can then connect to varied anchorage points located throughout the site with the Lanyard End of the SRL without repeatedly re-installing the SRL. To mount the Nano-Lok SRL on a Full Body Harness with the Single SRL Harness Interface:
 1. **Loosen the Harness Webbing:** Pull out on the Web Straps (A) where they pass through the bottom of the Dorsal D-Ring (B) until there is sufficient space to slide the Single SRL Interface between the Web Straps and Back Pad.
 2. **Open the Harness Interface:** Push down on the Locking Buttons (C) simultaneously and slide the Locking Pin (D) out.
 3. **Position the Harness Interface around the Web Straps:** With the Locking Buttons (C) facing out and Gate facing up, insert the Nose End of the Harness Interface (E) behind the Web Straps (A). Rotate the Harness Interface behind the Web Straps until the Harness Interface surrounds the the Web Straps. Pull the Web Straps back through the Dorsal D-Ring and Back Pad to secure the Harness Interface.
 4. **Attach the Nano-Lok SRL to the Harness Interface:** Slide the Swivel Eye on the SRL (F) over the Harness Interface's Locking Pin (D) and then push in the Locking Pin until it locks into place in the opposite end of the Harness Interface.

WARNING: The Red Band on the knob end of the Harness Interface Locking Pin will be exposed if the Harness Interface is unlocked. To avoid accidental release of the connection, always make sure the Harness Interface is locked before using the Harness and attached Nano-Lok SRL. Failure to do so could result in injury or death.

NOTE: It is also acceptable to connect the Nano-Lok SRL to the Harness Dorsal D-Ring with a Carabiner or Snaphook.

- **Twin SRL Harness Interface:** In climbing applications where 100% tie-off is required, the Twin SRL Harness Interface can be used to mount two Nano-Lok SRLs side-by-side on the back of a Full Body Harness just below the Dorsal D-Ring (see Figure 9). To mount two Nano-Lok SRLs on a Full Body Harness with the Twin SRL Harness Interface:
 1. **Loosen the Harness Webbing:** Pull out on the Web Straps (A) where they pass through the bottom of the Dorsal D-Ring (B) until there is sufficient space to slide the Twin SRL Interface between the Web Straps and D-Ring Pad.
 2. **Open the Harness Interface:** Push up on the Connector Insert (C) to unsnap the Clamps (D) from the Connector and then swing the Connector Insert up to unlock the Gate. Push the Gate (E) inward to open the Connector.
 3. **Thread the first Nano-Lok SRL onto the Harness Interface:** Insert the Nose of the Connector (F) through the Swivel Eye (G) on the SRL and then rotate the SRL around to the Gate End of the Connector (H). The Gate can be rotated toward the Nose to allow clearance for the Swivel Eye between the Gate and Spine of the Connector.
 4. **Position the Harness Interface around the Web Straps:** With the Gate facing up, insert the Nose of the Connector (F) behind the Web Straps (A). Rotate the Connector behind the Web Straps until the Connector surrounds the the Web Straps.
 5. **Add the second Nano-Lok SRL on the Harness Interface:** Slide the SRL's Swivel Eye (G) over the Nose of the Connector (F) and position the SRL Swivel Eye in the Nose End of the Connector (I). Swing the Gate (E) closed.
 6. **Close the Harness Interface:** Rotate the Connector Insert (C) forward so the Clamps (D) secure on the Connector. When properly closed, the Web Straps should pass through the Webbing Slot (J) at the top of the Connector Insert and the SRL Swivel Eyes should be secured in the Recesses (K) on either side of the Connector Insert. Once the Harness Interface is closed, pull the Web Straps (A) back through the Dorsal D-Ring and D-Ring Pad to eliminate slack in the webbing and secure the Connector between the Web Straps and D-Ring Pad.

NOTE: Older ExoFit harnesses may require a different Twin SRL Harness Interface. See Appendix A.

4.0 USE

WARNING: Do not alter or intentionally misuse this equipment. Consult Capital Safety when using this equipment in combination with components or subsystems other than those described in this manual. Some subsystem and component combinations may interfere with the operation of this equipment. Use caution when using this equipment around moving machinery, electrical hazards, chemical hazards, sharp edges, or overhead materials that may fall onto the lifeline. Do not loop the lifeline around small structural members. Failure to heed this warning may result in equipment malfunction, serious injury, or death.

WARNING: Consult your doctor if there is reason to doubt your fitness to safely absorb the shock from a fall arrest. Age and fitness seriously affect a worker's ability to withstand falls. Pregnant women or minors must not use DBI-SALA self retracting lifelines.

- 4.1 BEFORE EACH USE:** Before each use of this fall protection equipment carefully inspect it to assure it is in good working condition. Check for worn or damaged parts. Ensure all bolts are present and secure. Check that the lifeline is retracting properly by pulling out the line and allowing it to slowly retract. If there is any hesitation in retraction the unit should be removed from service and destroyed. Inspect the lifeline for cuts, frays, burns, crushing and corrosion. Check locking action by pulling sharply on the line. See Section 5 for inspection details. Do not use if inspection reveals an unsafe condition.
- 4.2 AFTER A FALL:** Any equipment which has been subjected to the forces of arresting a fall or exhibits damage consistent with the effect of fall arrest forces as described in Section 5, must be removed from service immediately and destroyed.
- 4.3 BODY SUPPORT:** A full body harness must be worn when using Nano-Lok SRLs. For general fall protection use, connect to the back (dorsal) D-ring.
- 4.4 MAKING CONNECTIONS:** Figure 10 illustrates harness and anchorage connections for Nano-Lok SRL Fall Arrest Systems. When using a hook to make a connection, ensure roll-out cannot occur (see Figure 5). Do not use hooks or connectors that will not completely close over the attachment object. Do not use non-locking snap hooks. The anchorage must meet the anchorage strength requirements stated in section 2.2. Follow the manufacturer's instructions supplied with each system component.
- 4.5 OPERATION:** Prior to use, inspect the SRL as described in section 5.0. Figure 10 shows system connections for typical Nano-Lok SRL applications. Connect the Nano-Lok SRL to a suitable anchorage or mount the SRL on the back of a Full Body Harness per the instruction in Section 3. On anchorage connected SRLs, connect the Hook (D) or Carabiner on the Load Indicator to the Dorsal D-Ring (A) on the Full Body Harness. On harness mounted SRLs, connect the Hook (D) or Carabiner to a suitable anchorage. Ensure connections are compatible in size, shape, and strength. Ensure hooks are fully closed and locked. Once attached, the worker is free to move about within the recommended working area at normal speeds. If a fall occurs the SRL will lock and arrest the fall. Upon rescue, remove the SRL from use. When working with an SRL, always allow the lifeline to recoil back into the device under control.

WARNING: Do not tie or knot the lifeline. Avoid lifeline contact with sharp or abrasive surfaces. Inspect the lifeline frequently for cuts, fraying, burns, or signs of chemical damage. Dirt, contaminants, and water can lower dielectric properties of the lifeline. Use caution near power lines.

- 4.6 TWIN SRL INTERFACE 100% TIE-OFF:** When two Nano-Lok SRLs are mounted side-by-side on the back of a Full Body Harness, the SRL Fall Arrest System can be used for continuous fall protection (100 % tie-off) while ascending, descending, or moving laterally (see Figure 11). With the Lanyard Leg of one SRL attached to an anchorage point, the worker can move to a new location, attach the unused Lanyard Leg of the other SRL to another anchorage point, and then disconnect from the original anchorage point. The sequence is repeated until the worker reaches the desired location. Considerations for Twin SRL 100% tie-off applications include the following:
- Never connect both SRL Lanyards to the same anchorage point (see Figure 12A).
 - Connecting more than one connector into a single anchorage (ring or eye) can jeopardize compatibility of the connection due to interaction between connectors and is not recommended.
 - Connection of each SRL Lanyard to a separate anchorage point is acceptable (Figure 12B).
 - Each connection location must independently support 2,248 lbs (10 kN) or be an engineered system, as with a Horizontal Lifeline.
 - Never connect more than one person at a time to the Twin SRL system (Figure 13).
 - Do not allow the Lanyards to become tangled or twisted together as this may prevent them from retracting.
 - Do not allow any lanyard to pass under arms or between legs during use.

4.7 AERIAL WORK PLATFORMS: Use of the Nano-Lok SRL on aerial work platforms is permissible, provided the following criteria are met:

1. Nano-Lok SRLs generally will not restrain workers from falling out of aerial work platforms or elevated working surfaces. To restrain users from falling out of aerial work platforms, Positioning Lanyards of sufficiently short lengths should be used.
2. Aerial work platforms must have guardrails or gates at all accessible edges along their perimeter unless anchorages for the Nano-Lok SRLs are located overhead. The edges on the top rails of all guardrails and gates over which the user might fall must have a minimum radius of 1/8 in. (0.3 cm).
3. Anchorages of appropriate strength and compatibility must always be used for securing Nano-Lok SRLs (see Section 2).
4. Swing fall hazards may exist, especially when working near corners or out away from anchorage points. Added fall clearance is needed where the potential for swing fall exists (see Figure 4).
5. All sharp edges which the Nano-Lok SRL's lifeline may contact during a fall must be eliminated or covered over. All edges the SRL lifeline may contact in a fall must be smooth with an edge radius of 1/8 in. (0.3 cm) or greater. Potential pinch points between adjacent surfaces where the lifeline may catch during a fall must be eliminated.

4.8 HORIZONTAL SYSTEMS: In applications where the Nano-Lok SRL is used in conjunction with a horizontal system (i.e. Horizontal Lifeline, Horizontal I-Beams Trolley), the SRL and horizontal system components must be compatible. Horizontal systems must be designed and installed under the supervision of a qualified engineer. Consult the horizontal system equipment manufacturer's instructions for details.

5.0 INSPECTION

5.1 i-Safe™ RFID TAG: The Nano-Lok SRL includes an i-Safe™ Radio Frequency Identification (RFID) tag (Figure 14). The RFID tag can be used in conjunction with the i-Safe handheld reading device to simplify inspection and inventory control and provide records for your fall protection equipment. If you are a first-time user, contact a Capital Safety Customer Service representative (see back cover); or if you have already registered, go to isafe.capitalsafety.com. Follow the instructions provided with your i-Safe handheld reader or software to transfer your data to your database.

5.2 INSPECTION FREQUENCY: The Nano-Lok SRL must be inspected at the intervals defined in "Section 2.5 - Inspection Frequency". Inspection procedures are described in the "Inspection & Maintenance Log" (Table 1).

5.3 UNSAFE OR DEFECTIVE CONDITIONS: If inspection reveals an unsafe or defective condition, remove the Nano-Lok SRL from service immediately and discard (see "Section 5.5 - Disposal").

5.4 PRODUCT LIFE: The functional life of Nano-Lok SRLs is determined by work conditions and maintenance. As long as the SRL passes inspection criteria, it may remain in service.

5.5 DISPOSAL: Dispose of the Nano-Lok SRL if it has been subjected to fall force or inspection reveals an unsafe or defective condition. Before disposing of the SRL, cut the Load Indicator off of the Web Lanyard or otherwise disable the SRL to eliminate the possibility of inadvertent reuse.

6.0 MAINTENANCE, SERVICING, AND STORAGE

6.1 CLEANING: Cleaning procedures for the Nano-Lok SRL are as follows:

- Periodically clean the exterior of the SRL using water and a mild soap solution. Position the SRL so excess water can drain out. Clean labels as required.
- Clean the Web Lifeline with water and mild soap solution. Rinse and thoroughly air dry. Do not force dry with heat. The lifeline should be dry before allowing it to retract into the housing. An excessive buildup of dirt, paint, etc. may prevent the lifeline from fully retracting back into the housing causing a potential free fall hazard.

IMPORTANT: If the lifeline contacts acids or other caustic chemicals, remove the SRL from service and wash with water and a mild soap solution. Inspect the SRL per Table 1 before returning to service.

6.2 SERVICE: Nano-Lok SRLs are not repairable. If the SRL has been subjected to fall force or inspection reveals an unsafe or defective condition, remove the SRL from service and discard (see "Section 5.5 - Disposal").

6.3 STORAGE/TRANSPORT: Store and transport Nano-Lok SRLs in a cool, dry, clean environment out of direct sunlight. Avoid areas where chemical vapors may exist. Thoroughly inspect the SRL after any period of extended storage.

7.0 SPECIFICATIONS

7.1 PERFORMANCE: Your Nano-Lok SRL has been tested and certified to the performance requirements of the standard(s) identified on the cover of this instruction manual. See "Section 2.0 - Limitations & Requirements" for performance specifications.

7.2 DIMENSIONS: Table 2 lists Nano-Lok SRL dimensions. Average working range for the Nano-Lok SRL is 6 ft. (1.8 m), but will vary slightly with length differences in the various End Connector options. Retracted and Extended length values in Table 2 are approximations based on the total length of the fully retracted/extended SRL and the applicable End Connectors.

7.3 LABELING: Figure 16 at the back of these instructions illustrates Nano-Lok SRL labels.

7.4 MATERIALS: See Table 2.

Table 1 – Inspection and Maintenance Log

Serial Number(s):		Date Purchased:	
Model Number:		Date of First Use:	
Inspection Date:		Inspected By:	
Component:	Inspection: (See Section 2 for Inspection Frequency)	Pass	Fail
SRL (Diagram 1)	Inspect for loose fasteners and bent or damaged parts.	<input type="checkbox"/>	<input type="checkbox"/>
	Inspect the Housing (A) for distortion, cracks, or other damage.	<input type="checkbox"/>	<input type="checkbox"/>
	Inspect the Swivel (B) and Swivel Eye (C) or Integral Connector (D) for distortion, cracks, or other damage. The Swivel should be attached securely to the SRL, but should pivot freely. The Swivel Eye or Integral Connector should rotate freely in the Swivel.	<input type="checkbox"/>	<input type="checkbox"/>
	The Web Lifeline (E) should pull out and retract fully without hesitation or creating a slack line condition.	<input type="checkbox"/>	<input type="checkbox"/>
	Ensure the SRL locks up when the Lifeline is jerked sharply. Lockup should be positive with no slipping.	<input type="checkbox"/>	<input type="checkbox"/>
	All labels must be present and fully legible (see Figure 16).	<input type="checkbox"/>	<input type="checkbox"/>
	Inspect the entire SRL for signs of corrosion.	<input type="checkbox"/>	<input type="checkbox"/>
Web Lifeline (Diagram 2)	Inspect the web lifeline for concentrated wear, frayed strands, broken yarn, burns, cuts, and abrasions. The lifeline must be free of knots throughout its length. Inspect for excessive soiling, paint build-up, and rust staining. Inspect for chemical or heat damage indicated by brown, discolored, or brittle areas. Inspect for ultraviolet damage indicated by discoloration and the presence of splinters and slivers on the lifeline surface.	<input type="checkbox"/>	<input type="checkbox"/>
Load Indicator (Diagram 3)	Inspect the Load Indicator to determine if it has been activated. There should be no evidence of elongation and the cover should be secure and free of tears or other damage.	<input type="checkbox"/>	<input type="checkbox"/>
End Connectors (Table 2)	Table 2 identifies the End Connectors that should be included on your Nano-Lok SRL model. Inspect all Snap Hooks, Carabiners, Rebar Hooks, Interfaces, etc. for signs of damage, corrosion, and proper working condition. Where present: Gates should open, close, lock, and unlock properly, and Locking Buttons and Locking Pins should function correctly.	<input type="checkbox"/>	<input type="checkbox"/>

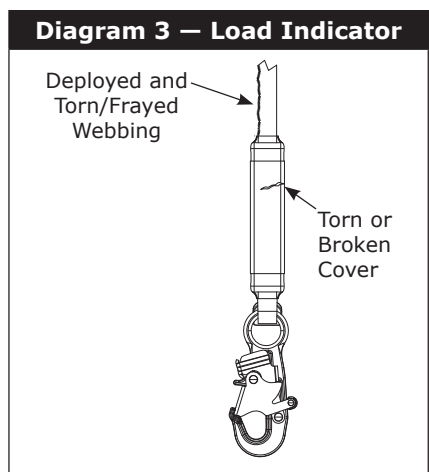
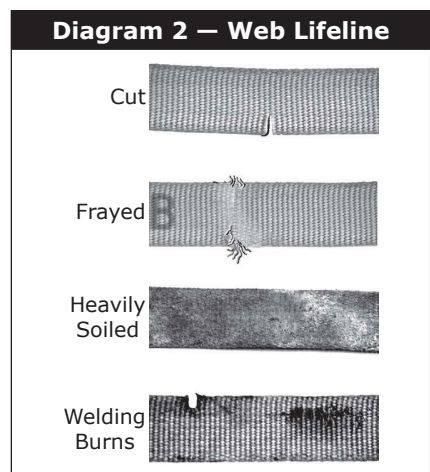
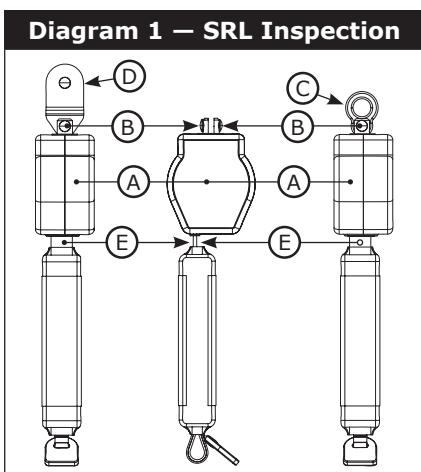

Corrective Action/Maintenance:	Approved By:
	Date:
Corrective Action/Maintenance:	Approved By:
	Date:
Corrective Action/Maintenance:	Approved By:
	Date:
Corrective Action/Maintenance:	Approved By:
	Date:

Table 2 – Specifications

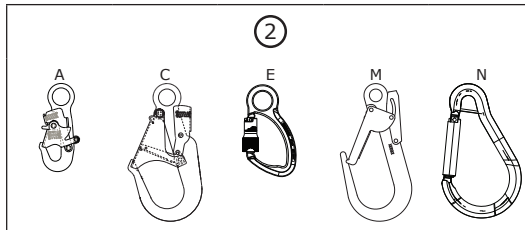
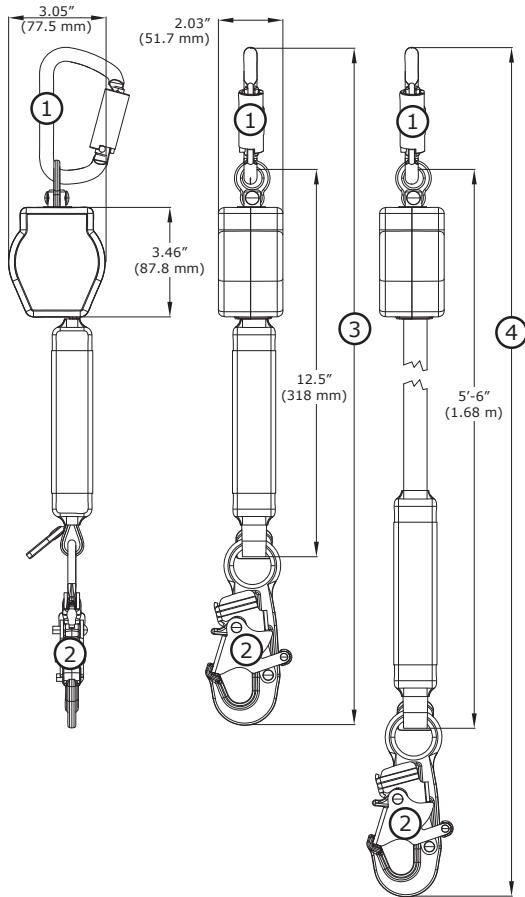
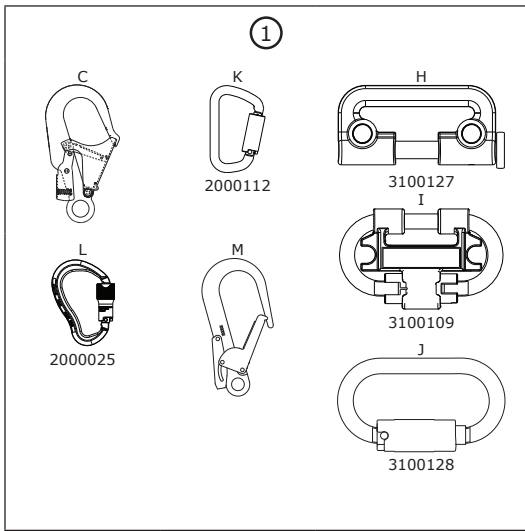

Model	End Connectors		Length (Retracted)		Length (Extended)	
	① Swivel	② Lanyard	③ in.	③ mm	④ ft.	④ m
3101201	I	EN 362	12.50	318.00	5.50	1.68
3101205	EN 362	EN 362	12.50	318.00	5.50	1.68
3101207	H	M	22.09	561.04	6.30	1.92
3101208	L	M	24.25	615.95	6.48	1.97
3101209	M	E	26.75	679.45	6.69	2.04
3101260	H	A	18.74	475.95	6.02	1.83
3101261	H	C	21.84	554.69	6.28	1.91
3101262	H	E	19.84	503.89	6.11	1.86
3101263	L	C	24.00	609.60	6.46	1.97
3101264	L	E	22.00	558.80	6.29	1.92
3101265	K	A	21.73	551.94	6.27	1.91
3101266	C	E	26.50	673.10	6.67	2.03
3101461	K	M	24.00	609.60	6.45	1.96
3101270	I	C	22.45	570.23	6.33	1.93
3101296	J	C	22.45	570.23	6.33	1.93
3101298	I	M	22.70	576.58	6.35	1.94
3101467	L	EN 362	17.00	431.80	5.88	1.79
3101487	L	N	25.50	647.70	6.58	2.00
3101521	H	C	21.22	538.94	6.23	1.90
3101522	H	M	22.09	561.04	6.30	1.92
3101523	K	A	21.73	551.94	6.27	1.91
3101524	I	C	21.83	554.48	6.28	1.91
3101525	I	M	22.70	576.58	6.35	1.94

① ② Connector:	Type:	Material:	Gate Opening
A	Snap Hook	Steel	3/4 in. (19 mm)
C	Rebar Hook	Aluminum	2-1/4 in. (57 mm)
E	Carabiner	Aluminum	3/4 in. (19 mm)
H	Single SRL Interface	Steel	11/16 in. (17 mm)
I	Twin SRL Interface	Steel w/Nylon Insert	3/4 in. (19 mm)
J	Twin SRL Interface (ExoFit Fixed D-Ring)	Steel	3/4 in. (19 mm)
K	Carabiner	Steel	1-3/16 in. (30 mm)
L	Carabiner	Aluminum	3/4 in. (19 mm)
M	Rebar Hook	Aluminum	2-1/4 in. (57 mm)
N	Carabiner	Aluminum	2-1/8 in. (54 mm)

Housing:	Nylon, UV Resistant	Motor Spring:	Stainless Steel
Drum:	Nylon, Type 6/6	Swivel:	Zinc Plated Steel
Fasteners:	Zinc Plated Steel Screws; Stainless Steel Rivets	Lifeline:	Dynema Polyester Web,
		Hot Work	Kevlar Nomex Web
Locking Pawls:	Stainless Steel	Load Indicator:	Cover: Denier Textured Nylon
Main Shaft:	Stainless Steel		Stitching: Polyester or Nylon Thread
			Web: Polyester

APPENDIX A - TWIN SRL FIXED D-RING HARNESS INTERFACE

Older ExoFit Full Body Harnesses with a Fixed D-Ring require a special Twin SRL Harness Interface to mount two Nano-Lok SRLs on the back of the harness just below the Dorsal D-Ring. The following Twin Nano-Lok SRL models are available for installation on ExoFit Fixed D-Ring harnesses:

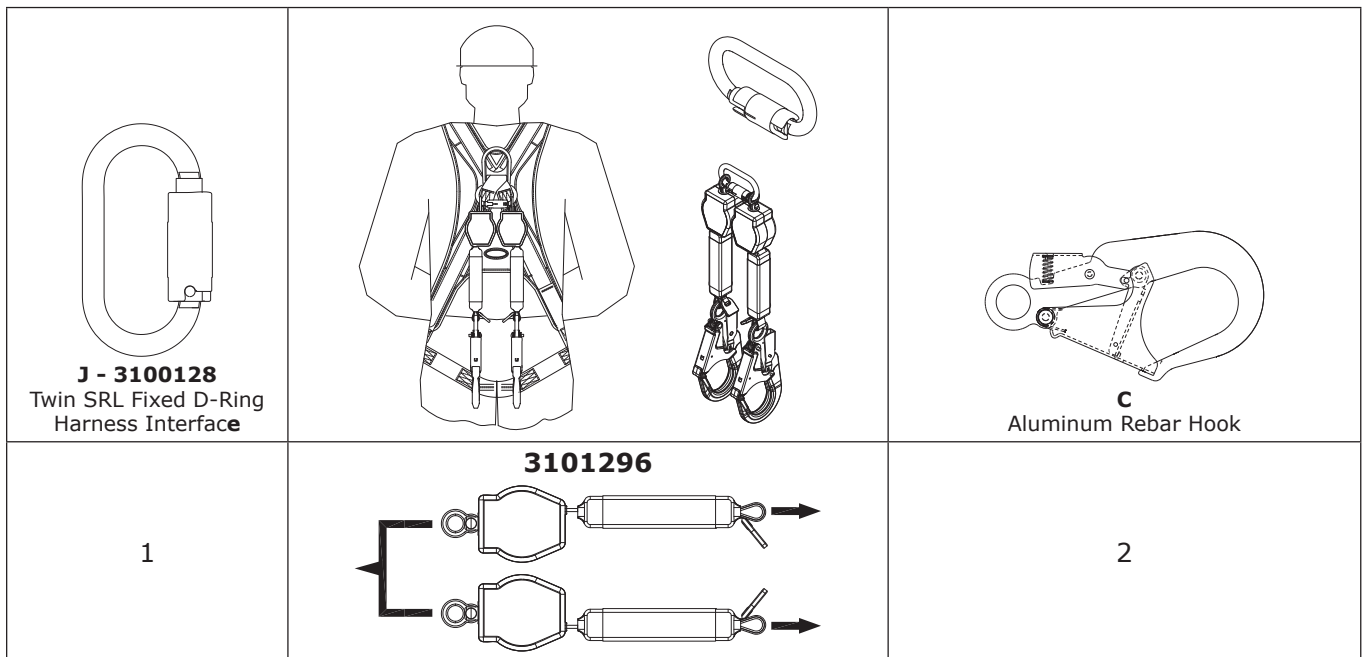

Harness Mounting: To mount two Nano-Lok SRLs on an ExoFit Full Body Harness with the Twin SRL Fixed D-Ring Harness Interface (Figure 15):

- Loosen the Harness Webbing:** Pull out on the Web Straps (A) where they pass through the bottom of the Dorsal D-Ring (B) until there is sufficient space to insert the Twin SRL Interface between the Web Straps and Back Pad.
- Open the Harness Interface:** With the Twin SRL Interface orientated as illustrated in Figure 15 - Step 2, push the Locking Sleeve (C) to the right and then turn clockwise to unlock the Gate (D). Swing the Gate (D) down to open.
- Thread the first Nano-Lok SRL onto the Harness Interface:** Insert the Nose of the Connector (E) through the Swivel Eye (F) on the SRL and then rotate the SRL around to the Gate End of the Connector (G). The Gate can be closed to allow clearance for the Swivel Eye between the Gate and Spine of the Connector.
- Position the Harness Interface around the Web Straps:** Insert the Nose of the Connector (E) behind the Web Straps (A). Rotate the Connector behind the Web Straps until the Connector surrounds the Web Straps.
- Add the second Nano-Lok SRL on the Harness Interface:** Slide the SRL's Swivel Eye (F) over the Nose of the Connector (E) and position the SRL Swivel Eye in the Nose End of the Connector.
- Close the Harness Interface:** Allow the Gate (D) to swing closed and the Locking Sleeve (C) to rotate back to locked position. Once the Harness Interface is closed, pull the Web Straps (A) back through the Dorsal D-Ring to eliminate slack in the webbing and secure the Harness Interface between the Web Straps and Back Pad.